



Bids and Awards Committee for Goods (BAC-G)

PROCUREMENT OF OFFICE FURNITURE AND FIXTURE (FIT-OUT PROJECT)

BID BULLETIN NO. 1

This Bid Bulletin provides the updated Technical Specifications and the attachment relative to the project.

A. REVISED TECHNICAL SPECIFICATIONS

ORIGINAL	REVISION
<p>Lot 3, Item 3 provided:</p> <p>TV SET, 65 INCHES Quantity: 5 sets ABC:Php80,000.00</p> <p>TECHNICAL SPECIFICATIONS: Screen Size: At least 65 inches Display: 4kUHD Resolution, Smart TV, AI 4K Processor</p> <p>HDR (High Dynamic Range) Refresh Rate: 60Hz Sound/ Audio Output: 20 W Speaker System: 2.0 Channel Color 100% Color Volume Connectivity: - Wi-Fi: Yes - Bluetooth Support: Yes - HDMI: At Least 2 ports - Ethernet: Yes - USB Port: At least 1</p> <p>Slim Design With 2 years warranty Must Include Accessories: - Remote Control - Wall Mount - TV Stand</p>	<p>Lot 3, Item 3 is revised to:</p> <p>TV SET, 65 INCHES Quantity: 5 sets <u>ABC: Php400,000.00</u></p> <p>TECHNICAL SPECIFICATIONS: Screen Size: At least 65 inches Display: 4kUHD Resolution, Smart TV, AI 4K Processor</p> <p>HDR (High Dynamic Range) Refresh Rate: 60Hz Sound/ Audio Output: 20 W Speaker System: 2.0 Channel Color 100% Color Volume Connectivity: - Wi-Fi: Yes - Bluetooth Support: Yes - HDMI: At Least 2 ports - Ethernet: Yes - USB Port: At least 1</p> <p>Slim Design With 2 years warranty Must Include Accessories: - Remote Control - Wall Mount - TV Stand</p>

“Annex A” provides the updated “Section VII. Technical Specifications/Terms of Reference” reflecting the subject revision.

B. ATTACHMENT TO THE TECHNICAL SPECIFICATIONS

As requested during the Pre-Bid Conference, this Bid Bulletin provides the Attachment to the Technical Specifications, which shows sample photos and layout. Please see “*Annex B*”.

C. SCHEDULE OF ACTIVITIES

Please take note of the following schedule:

ACTIVITIES	DATE/SCHEDULE
Deadline for Requests for Clarification, if any.	5:00 PM, 22 November 2024
Deadline of Issuance of Last Supplemental/Bid Bulletin, if any.	25 November 2024
Deadline of Submission and Receipt of Bids	12:00 PM, 02 December 2024
Opening of Bids	1:00 PM, 02 December 2024

The above changes further amend the bidding documents accordingly. **The Submission and Opening of Bids will be conducted face-to-face** at the **BCDA Corporate Center, 2nd Floor, Bonifacio Technology Center, 31st St. corner 2nd Ave, Bonifacio Global City, Taguig City**. Alternatively, bidders may opt to attend online via Zoom. The meeting link will be provided upon request by the prospective bidders to the BAC-G Secretariat through the email address bacgsecretariat@bcda.gov.ph.

For those attending in person, please consider the following guidelines:

- Attendees to the Opening of Bids are expected to follow the BCDA Health protocols and
- Observers/representatives who show signs of COVID-19-related symptoms are advised to attend online and will not be allowed to enter the BCDA premises.

This Bid Bulletin is being issued pursuant to Sections 22.5.2 and 22.5.3 of the 2016 Revised Implementing Rules and Regulations of Republic Act No. 9184.

Issued on **20 November 2024 (Wednesday)** in Taguig City.

BIDS AND AWARDS COMMITTEE FOR GOODS

By:



RICHARD BRIAN M. CEPE
Chairperson

Annex A
Updated “Section VII. Technical Specifications/ Terms of Reference”

Item	Specification	Statement of Compliance	
		<p><i>Bidders must state here either “Comply” or “Not Comply” against each of the individual parameters of each Specification stating the corresponding performance parameter of the equipment offered. Statements of “Comply” or “Not Comply” must be supported by evidence in a Bidders Bid and cross-referenced to that evidence. Evidence shall be in the form of manufacturer’s un-amended sales literature, unconditional statements of specification and compliance issued by the manufacturer, samples, independent test data etc., as appropriate. A statement that is not supported by evidence or is subsequently found to be contradicted by the evidence presented will render the Bid under evaluation liable for rejection. A statement either in the Bidder’s statement of compliance or the supporting evidence that is found to be false either during Bid evaluation, post-qualification or the execution of the Contract may be regarded as fraudulent and render the Bidder or supplier liable for prosecution subject to the applicable laws and issuances.</i></p>	
		<i>Comply</i>	<i>Not Comply</i>
	Lot 1		
1	OFFICE CHAIR Quantity: 247 units		

	<p>ABC:Php1,729,000.00</p> <p>TECHNICAL SPECIFICATIONS: Ergonomic High Back Deluxe 3D Headrest Taiwan Mesh 3D Soft PU Armrest 3D Padded Lumbar Support Molded foam cushion/Mesh Seat Reclining Mechanism up to 125 degrees Seat Slide Mechanism Pneumatic height adjustment, class 3 gas lift 330mm Aluminum Base Color Black Weight capacity minimum of 150kg With 1 year warranty on base, casters, gas lift</p>		
2	<p>OFFICE TABLE, 1.2M Quantity: 215 units ABC:Php1,935,000.00</p> <p>TECHNICAL SPECIFICATIONS: Freestanding Table, MFC Table Bullnose Edge L1.2m x W0.6m x H75cm Color Beige With 1 year warranty</p>		
3	<p>OFFICE TABLE, 1.5M Quantity: 36 units ABC:Php378,000.00</p> <p>TECHNICAL SPECIFICATIONS: Freestanding Table, MFC Table Bullnose Edge L1.5m x W0.6m x H75cm Color Beige With 1 year warranty</p>		
4	<p>MOBILE PEDESTAL Quantity: 251 units ABC:Php1,255,000.00</p>		

	<p>TECHNICAL SPECIFICATIONS: All metal construction with plastic molded top Nylon slide for all drawers Caster 55mm Gauge 0.9mm or Gauge 20 With pencil tray and file divider Flush handle With central locking system 2 small drawers and 1 big drawer H65cm x D56cm x W40cm Color Beige</p>		
5	<p>EXECUTIVE CHAIR Quantity: 30 units ABC:Php420,000.00</p> <p>TECHNICAL SPECIFICATIONS: Materials: PU Back And Seat Aluminum base Adjustable Bionic Spine Support. Backrest tilt tension and tilt angle adjustment. PU castor. Weight: 18kg Weight capacity: 200KG Warranty: 2 Years</p>		
6	<p>EXECUTIVE TABLE Quantity: 4 units ABC:Php140,000.00</p> <p>TECHNICAL SPECIFICATIONS: Size 2.2meters X 1.8meters X 75 cm E1 grade MFC board, Table top with 2.0mm same color PVC edge, Other is 1.5mm edge, Table top with 50mm thickness board, With a wire box (Changeable from left to right) With multiple storage feature</p>		
7	<p>MANAGERIAL TABLE Quantity: 19 units ABC:Php570,000.00</p>		

	<p>TECHNICAL SPECIFICATIONS:</p> <p>Size 1.8meters X 1.6meters X 75 cm E1 grade MFC board, Table top with 2.0mm same color PVC edge, Other is 1.5mm edge, Table top with 50mm thickness board, With a wire box (Changeable from left to right) With multiple storage feature</p>		
8	<p>MEETING ROOM CHAIR Quantity: 160 units ABC:Php800,000.00</p> <p>TECHNICAL SPECIFICATIONS: Ergonomic Chair Recline: 103-125° High Quality Mesh Upholstery Nylon Fixed Armrest Chrome Base 10mm Height and 3mm Horizontal Adjustable Lumbar Support Weight Capacity: 130Kg Recommended Height User: 165-170CM 2 years warranty</p>		
9	<p>BOARDROOM CHAIR Quantity: 30 units ABC:Php480,000.00</p> <p>TECHNICAL SPECIFICATIONS: Adjustable seat height & swivel 360 degrees Butterfly mechanism with tilt & lock function Seat: PU padded with foam + headrest + 3D armrest w/ soft PU arm pad Legs: Metal Base + BIFMA CLASS 3 gas lift + BIFMA PU Nylon Castor Weight Capacity: minimum 130Kg Width: at least 65 cm Depth: at least 51 cm Height: at least 119-129 cm</p>		

	<p>Seat Height: at least 45-56 cm Color is subject to the approval of the assigned Architect</p>		
10	<p>CONFERENCE TABLE, 6 SEATER Quantity: 8 units ABC:Php200,000.00</p> <p>TECHNICAL SPECIFICATIONS: Materials: MFC board material Dimension 1200mmx2100mmx750mm, 50mm thick top With provision for LAN Socket, 1 - Power Outlet and/or VGA HDMI, wire management Color is subject to the approval of the assigned Architect</p>		
11	<p>CONFERENCE TABLE, 10 SEATER Quantity: 1 unit ABC:Php50,000.00</p> <p>TECHNICAL SPECIFICATIONS: Materials: MFC board material Dimension 1200mmx3600mmx750mm, 50mm thick top With provision for LAN Socket, 4 - Power Outlet and/or VGA HDMI, wire management Color is subject to the approval of the assigned Architect</p>		
12	<p>CONFERENCE TABLE, 12 SEATER Quantity: 3 units ABC:Php210,000.00</p> <p>TECHNICAL SPECIFICATIONS: Materials: MFC board material Dimension 1500mmx4200mmx750mm, min 50 mm thick top With provision for LAN Socket, 4 - Power Outlet and/or VGA HDMI Color is subject to the approval of the assigned Architect</p>		
13	<p>PANTRY TABLE, HIGH Quantity: 8 units ABC:Php64,000.00</p> <p>TECHNICAL SPECIFICATIONS:</p>		

	Round dia 800mm MDF Board, Steel base		
14	RECEPTION TABLE Quantity: 2 units ABC:Php80,000.00 TECHNICAL SPECIFICATIONS: 2400 x 650 x 1050 mm, MDFBoard, please see attached Annex A - Layout of Reception Table		
15	OFFICE TABLE, HIGH Quantity: 8 units ABC:Php96,000.00 TECHNICAL SPECIFICATIONS: Electric Height Adjustable Single Motor Desk (120*60) (White)ax. Load Capacity: 110.231lbs/50kg Speed: 12.5mm/s Power Type: 100V-240V Decibel: <50dB Stroke: 17.7"/450mm Height Range: 72.5-117.5cm Recommended Table Top Dimensions: 120x60x1.6cm		
16	FILING CABINET Quantity: 27 units ABC:Php486,000.00 TECHNICAL SPECIFICATIONS: Dimensions: 177 (w) x 35 (d) x 83 (h) cm Material: Marine Plywood Finish: Duco White		
17	PODIUM Quantity: 1 unit ABC:Php18,000.00 TECHNICAL SPECIFICATIONS: Dimensions: 60 (w) x 33 (d) x 118 (h) cm Material: MDF Board Finish: Laminated, Beechwood or White		
18	SOFA SET Quantity: 2 units		

	<p>ABC:Php100,000.00</p> <p>TECHNICAL SPECIFICATIONS: Material: Euroflex Foam, Gmelina Wood Dimension: Length: 3 seater- 84 inches 2 seater- 63 inches</p>		
19	<p>LATERAL CABINET Quantity: 100 units ABC:Php1,200,000.00</p> <p>TECHNICAL SPECIFICATIONS: 3-Drawer Lateral Filing Cabinet with Anti-Tilt Lock Mechanism/ KD With Steel Handle Lock Compatible with A4,FC,letter and legal size files Color: Gray Load Capacity: 40 kgs per drawer Dimensions: 90(W)x103(H)x45(D)cm Weight: 52kgs</p>		
20	<p>VERTICAL CABINET Quantity: 32 units ABC:Php448,000.00</p> <p>TECHNICAL SPECIFICATIONS: Filing Cabinet with Vault inside Material: Metal Color: Gray Dimension: L18" x W25" x H55"</p>		
	<p>Lot 2 Supply, Delivery and Installation of Modular Partition</p> <p>Quantity: Please see below ABC:Php5,211,000.00</p> <p>General Technical Specifications:</p> <ul style="list-style-type: none"> 60mm thickness, Finish Powder Coated Frames, Navy/Teal Blue Fabric with Glass and Frosted Stickers, Dimension may vary 		

	<p>based on the actual verification of the winning supplier, Finishes and materials shall be the same on the existing modular partition; Includes supply, delivery and installation of electrical wirings, duplex type electrical outlet with grounding, 1 per table or total of 280 duplex outlet, in compliance with the electrical building specifications; re-layout of existing network cable</p> <ul style="list-style-type: none"> Quantity is subject to minor changes depending on the actual dimensions and layout of the modular partition. The winning contractor shall submit the final layout prior to the fabrication and execution of this project. 		
1	80 units - Modular Partition, 1.5m (h) x 1.2m (w)		
2	75 units - Modular Partition, 1.5m (h) x 1.0m (w)		
3	30 units - Modular Partition, 1.5m (h) x 0.9m (w)		
4	100 units - Modular Partition, 1.3m (h) x 1.2m (w)		
5	35 units - Modular Partition, 1.3m (h) x 1.0m (w)		
6	15 units - Modular Partition, 1.3m (h) x 0.9m (w)		

	Lot 3		
--	--------------	--	--

1	<p>REFRIGERATOR, 10.2 CU.FT Quantity: 2 units ABC:Php76,000.00</p> <p>TECHNICAL SPECIFICATIONS: No Frost Inverter, Two Door Bottom Freezer Easy to organize with a 3-layer freezer Less mixing of odors with a separate case in the bottom freezer Surround Cooling Airflow Removable Ice Box Sliding 2-1 Shelf (Freezer) 150kg. Tempered Glass Shelves LED Lighting Refrigerant R600a Storage Capacity: 269 L / 9.4 cu.ft. Ref Comp.: 205 L / 7.2 cu.ft. Freezer Comp.: 85 L / 3 cu.ft. 1 Year Warranty on Parts & Service At least 10 Years Warranty on Compressor</p>		
2	<p>TV SET, 85-86 INCHES Quantity: 2 sets ABC:Php378,000.00</p> <p>TECHNICAL SPECIFICATIONS: Screen Size: At least 85 Inches Display: 4kUHD Resolution, Smart TV, AI 4K Processor HDR (High Dynamic Range) Refresh Rate: 60Hz Sound/ Audio Output: 20 W Speaker System: 2.0 Channel Color 100% Color Volume Slim Design Connectivity: - Wi-Fi: Yes - Bluetooth Support: Yes - HDMI: At Least 2 ports - Ethernet: Yes - USB Port: At least 1 With 2 years warranty Must Include Accessories: - Remote Control - Wall Mount</p>		

	- TV Stand		
3	<p>TV SET, 65 INCHES Quantity: 5 sets <u>ABC:Php 400,000.00</u></p> <p>TECHNICAL SPECIFICATIONS: Screen Size: At least 65 inches Display: 4kUHD Resolution, Smart TV, AI 4K Processor</p> <p>HDR (High Dynamic Range) Refresh Rate: 60Hz Sound/ Audio Output: 20 W Speaker System: 2.0 Channel Color 100% Color Volume Connectivity: <ul style="list-style-type: none"> - Wi-Fi: Yes - Bluetooth Support: Yes - HDMI: At Least 2 ports - Ethernet: Yes - USB Port: At least 1 Slim Design With 2 years warranty Must Include Accessories: <ul style="list-style-type: none"> - Remote Control - Wall Mount - TV Stand </p>		
4	<p>Air Purifier Quantity: 3 units <u>ABC:Php75,000.00</u></p> <p>TECHNICAL SPECIFICATIONS: Scenting Machine with a high volume desktop aroma diffuser which can cover from 250 to 350 sq.m. With an adjustable pre-program system for scent intensity and scenting time periods 500ml Capacity Size dimension of at least 240mm x 275mm x 94.5mm Include 6 pieces - 500ml of aromatherapy oil</p>		

Note:

- ***Please see the attached Technical Specifications for sample photo reference.***
- ***All items must be of the latest (At least 2024) model for each product offered.***
- ***Color Scheme may vary depending on the approval of the BCDA Architect***

Bidder's Authorized Representative:

Name: _____

Legal capacity: _____



Signature: _____

Duly authorized to sign the Bid for and behalf of: _____

Date: _____

Annex B
ATTACHMENT TO THE TECHNICAL SPECIFICATIONS



OFFICE FURNITURE AND FIXTURE (FIT OUT PROJECT)				
LOT 1: SUPPLY, DELIVERY, AND INSTALLATION OF OFFICE FURNITURE AND EQUIPMENT (60 Calendar Days Duration)				
<i>General Note: Color may vary depending on the approval of the BCDA Architect</i>				
ITEM NO.	DESCRIPTION	QUANTITY	UNIT	SAMPLE PHOTOS
1	<p>OFFICE CHAIR ABC:Php1,729,000.00</p> <p>TECHNICAL SPECIFICATIONS: Ergonomic High Back Deluxe 3D Headrest Taiwan Mesh 3D Soft PU Armrest 3D Padded Lumbar Support Molded foam cushion/Mesh Seat Reclining Mechanism up to 125 degrees Seat Slide Mechanism Pneumatic height adjustment, class 3 gas lift 330mm Aluminum Base Color Black Weight capacity minimum of 150kg With 1 year warranty on base, casters, gas lift</p>	247	pcs	

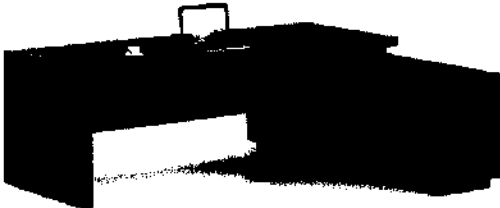

2	<p>OFFICE TABLE, 1.2M ABC:Php1,935,000.00</p> <p>TECHNICAL SPECIFICATIONS: Freestanding Table, MFC Table Bullnose Edge L1.2m x W0.6m x H75cm Color Beige With 1 year warranty</p>	215	pcs	
3	<p>OFFICE TABLE, 1.5M ABC:Php378,000.00</p> <p>TECHNICAL SPECIFICATIONS: Freestanding Table, MFC Table Bullnose Edge L1.5m x W0.6m x H75cm Color Beige With 1 year warranty</p>	36	pcs	



4	<p>MOBILE PEDESTAL ABC:Php1,255,000.00</p> <p>TECHNICAL SPECIFICATIONS: All metal construction with plastic molded top Nylon slide for all drawers Caster 55mm Gauge 0.9mm or Gauge 20 With pencil tray and file divider Flush handle With a central locking system 2 small drawers and 1 big drawer H65cm x D56cm x W40cm Color Beige</p>	251	pcs	
5	<p>EXECUTIVE CHAIR ABC:Php420,000.00</p> <p>TECHNICAL SPECIFICATIONS: Materials: PU Back And Seat Aluminum base Adjustable Bionic Spine Support. Backrest tilt tension and tilt angle adjustment. PU castor. Weight: 18kg Weight capacity: 200KG Warranty: 2 Years</p>	30	pcs	

6	<p>EXECUTIVE TABLE ABC:Php140,000.00</p> <p>TECHNICAL SPECIFICATIONS: Size 2.2meters X 1.8meters X 75 cm E1 grade MFC board, Tabletop with 2.0mm same color PVC edge, The other is 1.5mm edge, Tabletop with 50mm thickness board, With a wire box (Changeable from left to right) With multiple storage features</p>	4	pcs	
7	<p>MANAGERIAL TABLE ABC:Php570,000.00</p> <p>TECHNICAL SPECIFICATIONS: Size 1.8meters X 1.6meters X 75 cm E1 grade MFC board, Tabletop with 2.0mm same color PVC edge, The other is 1.5mm edge, Tabletop with 50mm thickness board, With a wire box (Changeable from left to right) With multiple storage features</p>	19	pcs	

8	<p>MEETING ROOM CHAIR ABC:Php800,000.00</p> <p>TECHNICAL SPECIFICATIONS: Ergonomic Chair Recline: 103-125° High-Quality Mesh Upholstery Nylon Fixed Armrest Chrome Base 10mm Height and 3mm Horizontal Adjustable Lumbar Support Weight Capacity: 130Kg Recommended Height User: 165-170CM 2 years warranty</p>	160	pcs	
9	<p>BOARDROOM CHAIR ABC:Php480,000.00</p> <p>TECHNICAL SPECIFICATIONS: Adjustable seat height & swivel 360 degrees Butterfly mechanism with tilt & lock function Seat: PU padded with foam + headrest + 3D armrest w/ soft PU arm pad Legs: Metal Base + BIFMA CLASS 3 gas lift + BIFMA PU Nylon Castor Weight Capacity: minimum 130Kg Width: at least 65 cm Depth: at least 51 cm Height: at least 119-129 cm Seat Height: at least 45-56 cm</p>	30	pcs	

	Color is subject to the approval of the assigned Architect			
10	<p>CONFERENCE TABLE, 6 SEATER ABC:Php200,000.00</p> <p>TECHNICAL SPECIFICATIONS: Materials: MFC board material Dimension 1200mmx2100mmx750mm, 50mm thick top With provision for LAN Socket, 1 - Power Outlet and/or VGA HDMI, wire management Color is subject to the approval of the assigned Architect</p>	8	pc	
11	<p>CONFERENCE TABLE, 10 SEATER ABC:Php50,000.00</p> <p>TECHNICAL SPECIFICATIONS: Materials: MFC board material Dimension 1200mmx3600mmx750mm, 50mm thick top With provision for LAN Socket, 4 - Power Outlet and/or VGA HDMI, wire management Color is subject to the approval of the assigned Architect</p>	1	pc	

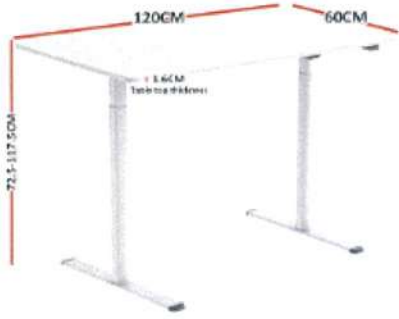
12	<p>CONFERENCE TABLE, 12 SEATER ABC:Php210,000.00</p> <p>TECHNICAL SPECIFICATIONS: Materials: MFC board material Dimension 1500mmx4200mmx750mm, min 50 mm thick top With provision for LAN Socket, 4 - Power Outlet and/or VGA HDMI Color is subject to the approval of the assigned Architect</p>	3	pc	
13	<p>PANTRY TABLE, HIGH ABC:Php64,000.00</p> <p>TECHNICAL SPECIFICATIONS: Round dia 800mm MDF Board, Steel base</p>	8	pcs	
14	<p>RECEPTION TABLE ABC:Php80,000.00</p> <p>TECHNICAL SPECIFICATIONS: 2400 x 650 x 1050 mm, MDFBoard, please see attached Annex A - Layout of Reception Table</p>	2	set	

<p>15</p>	<p>OFFICE TABLE, HIGH ABC:Php96,000.00</p> <p>TECHNICAL SPECIFICATIONS: Electric Height Adjustable Single Motor Desk (120*60) (White)ax. Load Capacity: 110.231lbs/50kg Speed: 12.5mm/s Power Type: 100V-240V Decibel: <50dB Stroke: 17.7"/450mm Height Range: 72.5-117.5cm Recommended Table Top Dimensions: 120x60x1.6cm</p>	<p>8</p>	<p>pcs</p>	
<p>16</p>	<p>FILING CABINET ABC:Php486,000.00</p> <p>TECHNICAL SPECIFICATIONS: Dimensions: 177 (w) x 35 (d) x 83 (h) cm Material: Marine Plywood Finish: Duco White</p>	<p>27</p>	<p>pcs</p>	

17	<p>PODIUM ABC:Php18,000.00</p> <p>TECHNICAL SPECIFICATIONS: Dimensions: 60 (w) x 33 (d) x 118 (h) cm Material: MDF Board Finish: Laminated, Beechwood or White</p>	1	pcs	
18	<p>SOFA SET ABC:Php100,000.00</p> <p>TECHNICAL SPECIFICATIONS: Material: Euroflex Foam, Gmelina Wood Dimension: Length: 3 seater- 84 inches 2 seater- 63 inches</p>	2	pcs	

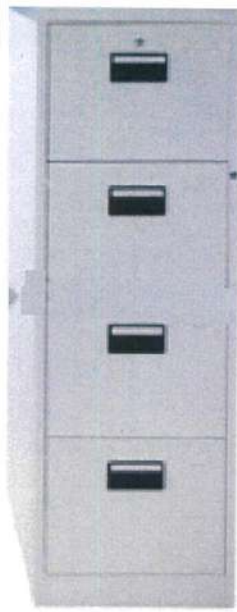
19	<p>LATERAL CABINET ABC:Php1,200,000.00</p> <p>TECHNICAL SPECIFICATIONS: 3-Drawer Lateral Filing Cabinet with Anti-Tilt Lock Mechanism/ KD With Steel Handle Lock Compatible with A4,FC,letter and legal size files Color: Gray Load Capacity: 40 kgs per drawer Dimensions: 90(W)x103(H)x45(D)cm Weight: 52kgs</p>	100	pcs	
20	<p>VERTICAL CABINET ABC:Php448,000.00</p> <p>TECHNICAL SPECIFICATIONS: Filing Cabinet with Vault inside Material: Metal Color: Gray Dimension: L18" x W25" x H55"</p>	32	pcs	

LOT 2: SUPPLY, DELIVERY, AND INSTALLATION OF MODULAR OFFICE PARTITION (60 Calendar Days Duration)

ABC:Php5,211,000.00

TECHNICAL SPECIFICATIONS:

60mm thickness, Finish Powder Coated Frames, Navy/Teal Blue Fabric with Glass and Frosted Stickers, Dimension may vary based on the actual verification of the winning supplier, Finishes and materials shall be the same on the existing modular partition; Includes supply, delivery and installation of electrical wirings, duplex type electrical outlet with grounding, 1 per table or total of 280 duplex outlet, in compliance with the electrical building specifications; re-layout of existing network cable
Please see attached Annex B for Modular Partition Layout

Note: Quantity is subject to minor changes depending on the actual dimensions and layout of the modular partition. The winning contractor shall submit the final layout prior to the fabrication and execution of this project.

ITEM NO.	DESCRIPTION	QUANTITY	UNIT	SAMPLE PHOTOS
----------	-------------	----------	------	---------------

1	Modular Partition, 1.5m (h) x 1.2m (w)	80	pcs	
2	Modular Partition, 1.5m (h) x 1.0m (w)	75	pcs	
3	Modular Partition, 1.5m (h) x 0.9m (w)	30	pcs	
4	Modular Partition, 1.3m (h) x 1.2m (w)	100	pcs	
5	Modular Partition, 1.3m (h) x 1.0m (w)	35	pcs	
6	Modular Partition, 1.3m (h) x 0.9m (w)	15	pcs	
LOT 3: SUPPLY AND DELIVERY AND INSTALLATION OF APPLIANCES (60 Calendar Days Duration)				
ITEM NO.	DESCRIPTION	QUANTITY	UNIT	SAMPLE PHOTOS

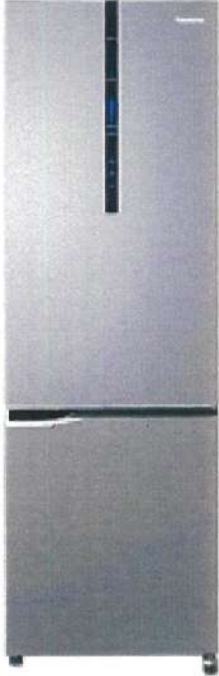
1	<p>REFRIGERATOR, 10.2 CU.FT ABC:Php76,000.00</p> <p>TECHNICAL SPECIFICATIONS: No Frost Inverter, Two Door Bottom Freezer Easy to organize with a 3-layer freezer Less mixing of odors with a separate case in the bottom freezer Surround Cooling Airflow Removable Ice Box Sliding 2-1 Shelf (Freezer) 150kg. Tempered Glass Shelves LED Lighting Refrigerant R600a Storage Capacity: 269 L / 9.4 cu.ft. Ref Comp.: 205 L / 7.2 cu.ft. Freezer Comp.: 85 L / 3 cu.ft. 1 Year Warranty on Parts & Service At least 10 Years Warranty on Compressor</p>	2	unit	
---	------------------------------------------------------------------------------------------------------------------------------------------------------------------------------------------------------------------------------------------------------------------------------------------------------------------------------------------------------------------------------------------------------------------------------------------------------------------------------------------------------------------------------------------------------------------------------------------------------------------------------------------------------------	---	------	-------------------------------------------------------------------------------------

2	<p>TV SET, 85-86 INCHES ABC:Php378,000.00</p> <p>TECHNICAL SPECIFICATIONS: Screen Size: At least 85 Inches Display: 4kUHD Resolution, Smart TV, AI 4K Processor HDR (High Dynamic Range) Refresh Rate: 60Hz Sound/ Audio Output: 20 W Speaker System: 2.0 Channel Color 100% Color Volume Slim Design Connectivity: - Wi-Fi: Yes - Bluetooth Support: Yes - HDMI: At Least 2 ports - Ethernet: Yes - USB Port: At least 1</p> <p>With 2 years warranty Must Include Accessories: - Remote Control - Wall Mount - TV Stand</p>	2	sets	
---	-------------------------------------------------------------------------------------------------------------------------------------------------------------------------------------------------------------------------------------------------------------------------------------------------------------------------------------------------------------------------------------------------------------------------------------------------------------------------------------------------------------------------------------------------------------------------------------------------------------------------------------------------------------	---	------	-------------------------------------------------------------------------------------

3	<p>TV SET, 65 INCHES ABC:Php400,000.00</p> <p>TECHNICAL SPECIFICATIONS: Screen Size: At least 65 inches Display: 4kUHD Resolution, Smart TV, AI 4K Processor</p> <p>HDR (High Dynamic Range) Refresh Rate: 60Hz Sound/ Audio Output: 20 W Speaker System: 2.0 Channel Color 100% Color Volume Connectivity:</p> <ul style="list-style-type: none"> - Wi-Fi: Yes - Bluetooth Support: Yes - HDMI: At Least 2 ports - Ethernet: Yes - USB Port: At least 1 <p>Slim Design With 2 years warranty Must Include Accessories:</p> <ul style="list-style-type: none"> - Remote Control - Wall Mount - TV Stand 	5	sets	
---	------------------------------------------------------------------------------------------------------------------------------------------------------------------------------------------------------------------------------------------------------------------------------------------------------------------------------------------------------------------------------------------------------------------------------------------------------------------------------------------------------------------------------------------------------------------------------------------------------------------------------------------------------------------------------------------------------------------------------------------------------------------------------	---	------	-------------------------------------------------------------------------------------

4	<p>Air Purifier ABC:Php75,000.00</p> <p>TECHNICAL SPECIFICATIONS: Scenting Machine with a high volume desktop aroma diffuser which can cover from 250 to 350 sq.m. With an adjustable pre-program system for scent intensity and scenting time periods 500ml Capacity Size dimension of at least 240mm x 275mm x 94.5mm Include 6 pieces - 500ml of aromatherapy oil</p>	3	pcs	
---	-----------------------------------------------------------------------------------------------------------------------------------------------------------------------------------------------------------------------------------------------------------------------------------------------------------------------------------------------------------------------------------------------------------------------------	---	-----	-------------------------------------------------------------------------------------

MODULAR PARTITION

PERIMETER / BOUNDARY WALLS (1.50 m Height)	
(dimension)	(quantity)
1.20 (L) x 1.50 (H)	74 Nos.
1.00 (L) x 1.50 (H)	69 Nos.
0.90 (L) x 1.50 (H)	26 Nos.

INTERIOR WALLS (1.30 m Height)	
(dimension)	(quantity)
1.20 (L) x 1.30 (H)	94 Nos.
1.00 (L) x 1.30 (H)	29 Nos.
0.90 (L) x 1.30 (H)	9 Nos.

(Revised Quantity based on revised Plan)



A BTC-BCDA OFFICE MASTER PLAN
SCALE 1:100



PROJECT TITLE: REDEVELOPMENT OF BCDA OFFICES BONIFACIO TECHNOLOGY CENTRE BONIFACIO GLOBAL CITY, TAGUIG	GENERAL NOTE: 1. CONTRACTOR SHALL BE RESPONSIBLE FOR OBTAINING ALL NECESSARY PERMITS AND APPROVALS FROM THE APPROPRIATE AGENCIES. 2. CONTRACTOR SHALL BE RESPONSIBLE FOR OBTAINING ALL NECESSARY PERMITS AND APPROVALS FROM THE APPROPRIATE AGENCIES. 3. CONTRACTOR SHALL BE RESPONSIBLE FOR OBTAINING ALL NECESSARY PERMITS AND APPROVALS FROM THE APPROPRIATE AGENCIES. 4. CONTRACTOR SHALL BE RESPONSIBLE FOR OBTAINING ALL NECESSARY PERMITS AND APPROVALS FROM THE APPROPRIATE AGENCIES. 5. CONTRACTOR SHALL BE RESPONSIBLE FOR OBTAINING ALL NECESSARY PERMITS AND APPROVALS FROM THE APPROPRIATE AGENCIES. 6. CONTRACTOR SHALL BE RESPONSIBLE FOR OBTAINING ALL NECESSARY PERMITS AND APPROVALS FROM THE APPROPRIATE AGENCIES. 7. CONTRACTOR SHALL BE RESPONSIBLE FOR OBTAINING ALL NECESSARY PERMITS AND APPROVALS FROM THE APPROPRIATE AGENCIES. 8. CONTRACTOR SHALL BE RESPONSIBLE FOR OBTAINING ALL NECESSARY PERMITS AND APPROVALS FROM THE APPROPRIATE AGENCIES. 9. CONTRACTOR SHALL BE RESPONSIBLE FOR OBTAINING ALL NECESSARY PERMITS AND APPROVALS FROM THE APPROPRIATE AGENCIES. 10. CONTRACTOR SHALL BE RESPONSIBLE FOR OBTAINING ALL NECESSARY PERMITS AND APPROVALS FROM THE APPROPRIATE AGENCIES.	DESIGNED BY: AUSTIN RAYUNJO O. REYES CHIEF AEC	RECOMMENDED APPROVAL: MARIA JOSEFINA V. PE VICE PRESIDENT PMO	APPROVED BY: ATTY. GERBA Z. KALALO EXECUTIVE VICE PRESIDENT BCDA	SHEET CONTENT: BTC-BCDA OFFICE MASTER PLAN (OFFICE REDEVELOPMENT)	REVISIONS: NO. DATE BY REVISIONS	DATE: 2024	SCALE: 1:100	APP. NO.: 1	APP. DATE: 2024	APP. BY: [Signature]	APP. TITLE: [Title]
---------------------------------------------------------------------------------------------------------------------------	-------------------------------------------------------------------------------------------------------------------------------------------------------------------------------------------------------------------------------------------------------------------------------------------------------------------------------------------------------------------------------------------------------------------------------------------------------------------------------------------------------------------------------------------------------------------------------------------------------------------------------------------------------------------------------------------------------------------------------------------------------------------------------------------------------------------------------------------------------------------------------------------------------------------------------------------------------------------------------------------------------------------------------------------------------------------------------------------------------------------------------------------------------------------------------------------------------------------------------------------------------------	-------------------------------------------------------------	-------------------------------------------------------------------------------	----------------------------------------------------------------------------------	--------------------------------------------------------------------------------	--------------------------------------------	----------------------	------------------------	-----------------------	---------------------------	--------------------------------	-------------------------------